

SAMSUNG



## High Resolution 12X Vandal Dome Camera **SVD-4700** User Guide

Before installing and operating this product,  
please read this manual thoroughly.

ENGLISH

Thank you for purchasing a **SAMSUNG CCD CAMERA**.

Before operating the camera, confirm the camera model and correct input power voltage. In order to that you can understand this manual thoroughly, we will introduce our model description.

#### ■ SVD-4700 SERIES

- NTSC MODEL SVD-4700N
- PAL MODEL SVD-4700P

#### ■ MODEL DESCRIPTION

- SVD-4700X



#### • SIGNAL SYSTEM

- N → NTSC MODEL
- P → PAL MODEL

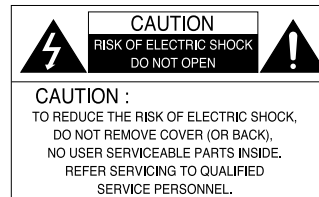

The lightning flash with an arrowhead symbol, within an equilateral triangle is intended to alert the user to the presence of uninsulated "dangerous voltage" within the product's enclosure that may be of sufficient magnitude to constitute a risk of electric shock to persons.



The exclamation point within an equilateral triangle is intended to alert the user to the presence of important operating and maintenance (servicing) instructions in the literature accompanying the appliance.

**INFORMATION**-This equipment has been tested and found to comply with limits for a Class A digital device, pursuant to part 15 of the FCC Rules. These limits are designed to provide reasonable protection against harmful interference when the equipment is operated in a commercial environment. This equipment generates, uses, and can radiate radio frequency energy and, if not installed and used in accordance with the instruction manual, may cause harmful interference to radio communications. Operation of this equipment in a residential area is likely to cause harmful interference in which case the user will be required to correct the interference at his own expense.

**WARNING** - Changes or modifications not expressly approved by the manufacturer could void the user's authority to operate the equipment.

**CAUTION :** To prevent electric shock and risk of fire hazards:

- ◆ Do NOT use power sources other than that specified.
- ◆ Do NOT expose this appliance to rain or moisture.

This installation should be made by a qualified service person and should conform to all local codes.

- Features ..... 5
- Warnings & Cautions ..... 6
- Precautions ..... 7
- Components and Accessories ..... 8
- Overview ..... 9
- Installation ..... 10
  - Installation ..... 10
  - Adjust the panning, tilting and rotate mechanism while checking the position on the monitor... 10
- Connection ..... 12
  - Connecting To Monitor ..... 12
  - Connecting To Power ..... 13
  - RS-485 communication control ..... 14
  - Using Coaxial Communications ..... 15
- Operating Your Camera ..... 16
  - Menu Configuration ..... 16
  - Menu Setup ..... 17
    - SSDR (Samsung Super Dynamic Range) ..... 18
    - White Balance (White Bal) ..... 19
    - BACKLIGHT ..... 20
    - Motion Detection ..... 22
    - FOCUS ..... 24
    - EXPOSURE ..... 29
    - SPECIAL ..... 33
    - RESET ..... 41
    - EXIT ..... 41
- Troubleshooting ..... 42
- Specifications ..... 43
- Dimension ..... 45

## A/F 12X Optical Zoom

The built-in SVD-4700 optical zoom lens is a highly durable component. It features auto focus, auto iris, and zoom functions.

## Miscellaneous Functions

HLC(High Light Compensation), SENS-UP, FLIP(H/V-REV), D-ZOOM, SHARPNESS, MOTION DETECTION and PRIVACY functions are provided.

## High Resolution

By adopting a diagonal 6mm(1/3") 410,000 (NTSC) pixel, 470,000(PAL) pixel SONY CCD, the camera produces clear picture quality with a horizontal resolution of 580 TV line in color and a horizontal resolution of 680 TV line in BW mode.

## SSNR 3 (Samsung Super Noise Reduction)

The high-performance W-V DSP chip effectively removes low-light gain noise and ghosting to provide clear images even in dark environments.

## DIS (Digital Image Stabilizer)

The DIS function compensates for any camera movement, to produce more stable pictures.

## IP66 Approved Dust and Rain Resistant

With dust and rain resistant design, the camera can be installed outside under building eaves or places that are exposed to the dust and rain.

## SSDR (Samsung Super Dynamic Range)

For images with high contrast between bright and dark areas from difficult lighting conditions such as backlighting, this camera selectively illuminates darker areas while retaining the same light level for brighter areas to even out the overall brightness.

## DAY&NIGHT(ICR)

This camera has a function that automatically selects the mode that is appropriate for daytime or night-time conditions. The COLOR mode operates in daytime conditions to provide optimum colors, and BW mode operates in night-time conditions to enhance the definition of the image.

## Communication

RS-485, Coaxial communication methods are supported.

- RS-485 Communications : STW(SPD), Pelco-P, Pelco-D, Vicon, Panasonic, Bosch, Honeywell, SEC, AD
- Coaxial Communications : Pelco Coaxitron

## OSD

The camera's OSD is complimented by 12 foreign languages.

- NTSC : Korean, English, French, Spanish, Japanese, Portuguese
- PAL : English, French, German, Spanish, Italian, Chinese, Russian, Czech, Polish, Portuguese

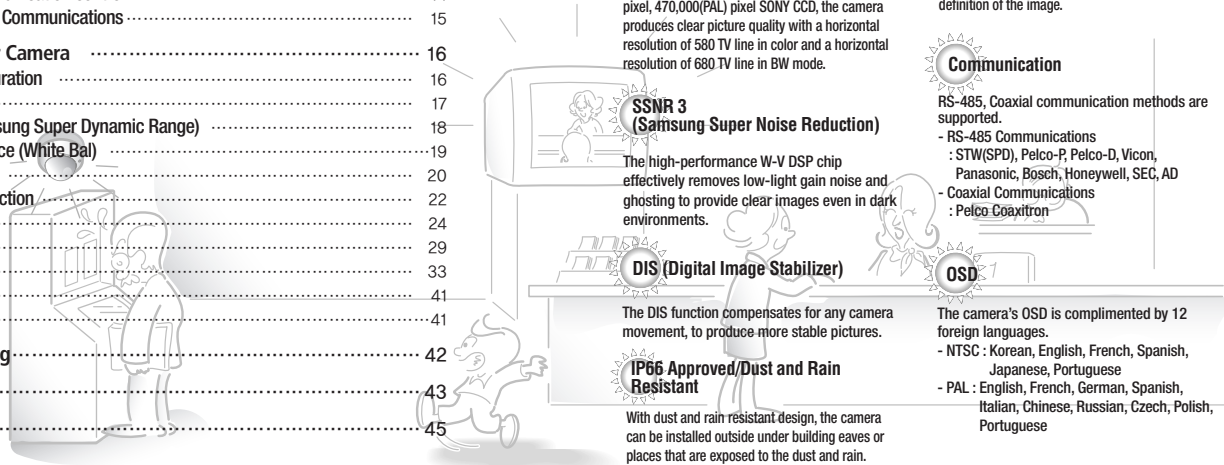



Samsung Techwin cares for the environment at all product manufacturing stages to preserve the environment, and is taking a number of steps to provide customers with more environment-friendly products. The Eco mark represents Samsung Techwin's will to create environment-friendly products, and indicates that the product satisfies the EU RoHS Directive.

## Warnings & Cautions

This information is provided to ensure your safety and to prevent any losses, financial or otherwise. Please read it carefully and use the product accordingly.

- \* For product inquiries, please contact the retail shop where you bought the camera. The use of equipment such as an aerial ladder while providing after-sales service shall be at your expense.
- \* Separate the power plug during a thunder storm.
- \* This product is only part of a surveillance system. Therefore, we can't compensate for material loss and/or personal injuries by robbery, fire, natural disaster or something like this type.

### Warning/Attention/Special Mark Messages

	Ignoring this information may result in material loss and/or serious personal injuries including death.		Ignoring this information may result in material loss and/or a slight injuries.
	Indicates "Never Allowed."		Indicates "No Disassembling."



#### Correct Disposal of This Product (Waste Electrical & Electronic Equipment)

(Applicable in the European Union and other European countries with separate collection systems)

This marking shown on the product or its literature, indicates that it should not be disposed with other household wastes at the end of its working life. To prevent possible harm to the environment or human health from uncontrolled waste disposal, please separate this from other types of wastes and recycle it responsibly to promote the sustainable reuse of material resources.

Household users should contact either the retailer where they purchased this product, or their local government office, for details of where and how they can take this item for environmentally safe recycling.

Business users should contact their supplier and check the terms and conditions of the purchase contract. This product should not be mixed with other commercial wastes for disposal.

## Precautions

Do not install under extreme temperature conditions.



Use only under temperature conditions between -10°C and +50°C. Provide good ventilation when using in high temperature conditions.

Do not install in high humidity environment.



May lower image quality.

Do not install under unstable lighting conditions.



Severe lighting changes or flickering may hinder normal camera operation.

Avoid touching the camera lens.



The lens is the most important component of the camera. Be careful not to smear it with fingerprints.

Do not drop the camera or subject it to physical shock.



May cause a product malfunction.

Never keep the camera face to strong light directly.



May damage the CCD.

## Precautions

Do not expose the camera to radioactivity.



Radioactivity exposure may damage the CCD.

### Notes

- Exposure to a spotlight or an object emitting strong light may cause smear or blooming.
- Ensure that the power source complies with normal specifications before supplying it to the camera.

## Components and Accessories



- 1 SVD-4700    2 USER Manual    3 Ø5 Tapping Screw 4EA    4 Quick Install Guide  
5 Wrench    6 Template    7 DC12V/500mA Adaptor    8 Installation Video Output Cable

※ The set for America does not include the power adapter.

## Overview

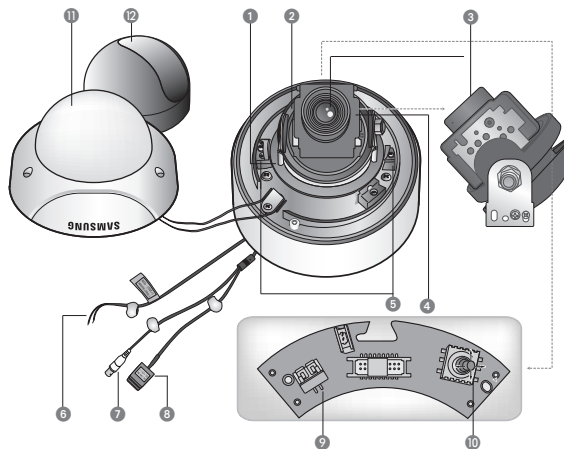

- 1 Pan Base : Control panning angle of camera.
- 2 Rotate Base : Control rotating angle of camera.
- 3 12x Zoom Module
- 4 Front Cover
- 5 Pan Base Holding Screws : Fix panned position.
- 6 RS-485 Control Terminal : The detailed description refers to p14.
- 7 Video Output Jack : Video signals are output through this port. Connect this port to the Video IN port of a monitor.
- 8 Power Input Terminal : Connect the power as specified for each model here.
- 9 Video Output terminal to Monitor : Used for monitoring of video output when camera installation.
- 10 Function Setup Switch : Display the menu on the screen and move the cursor to four directions to confirm status or after changing a selected item.
- 11 Dome Cover
- 12 Inner Cover

# Installation

## Installation



### Notes

- The installation should be done by qualified service personnel or system installers.
- If the ceiling material is not strong enough to hold the installation screws, the camera may fall off. Reinforce the ceiling as needed.
- Take care not to drop the product during installation. Do not allow anyone to stand below the installation area.

1. Remove the dome cover and inner cover from the main body by loosening the three dome cover screws.

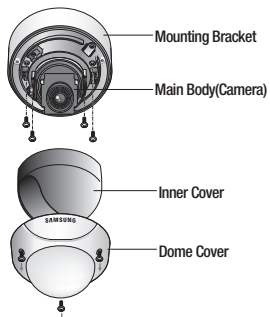

2. And then remove the main body from the mounting bracket by the four main body screws.

Adjust the panning, tilting and rotate mechanism while checking the position on the monitor

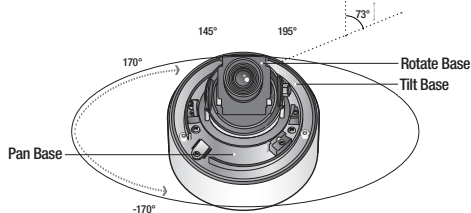

- 1 You can adjust camera to any direction by using the Pan, Tilt, Rotate mechanism.
  - Pan Base moves by 170° in each direction or 340° in total.
  - Tilt Base covers 73° in each direction or 146° in total.
  - The angle range of the Rotate Base is the same as that of the Pan Base. But one direction range is 195° and another is 145°

### 2 Methods of adjustment

#### • Wall installation

- 1 After mounting the camera to the wall, loosen the rotate base holding screws.
- 2 Adjust to the correct panning angle.
- 3 Then adjust the tilt angle by rotating the base.
- 4 Once complete re-tighten the rotate base holding screws.

#### • Ceiling installation

- 1 After mounting the camera to the ceiling, loosen the rotate base holding screws.
- 2 Adjust to the correct panning angle.
- 3 Then adjust the tilt angle by rotating the base.
- 4 Once complete re-tighten the rotate base holding screws.



### Notes

- When adjusting the rotating angle, loosen rotate base holding screw as follows Figures. Then tighten it again.
- When adjusting the tilting angle, grip the tilt base and adjust tilting angle.
- When adjusting the panning angle, loosen pan base holding screws as shown below and then re-tighten.

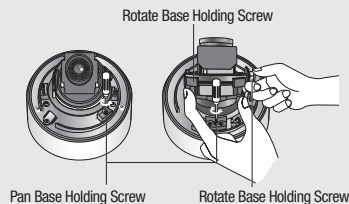

- When adjusting the tilt mechanism hold the Tilt base and NOT the lens.

# Connection

## Connecting to Monitor

Please connect the video output terminal located on the back of the camera to the monitor.

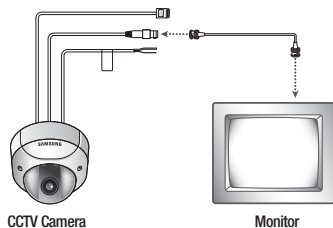

- The connection method varies depending on the type of monitor and accessories. Please refer to the user's manual for each instrument.
- Please turn off the power when connecting.
- Please select Hi-Z on the 75Ω/Hi-Z switch for the intermediate video TV set and select 75Ω for the Intermediate device as shown in the picture below.

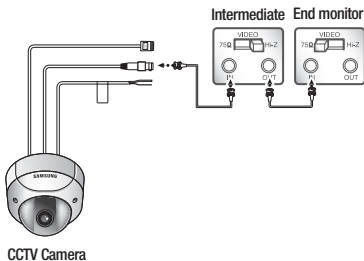

## Connecting to Power

The recommended adaptor specification for SVD-4700 is DC 12V / 500mA / AC24V / 500mA.

Please check the standard power requirement before connecting the power.

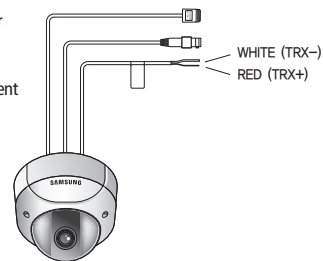

When the resistance value of copper wire is at [20°C(68°F)]

Copper wire size(AWG)	#24(0.22mm <sup>2</sup> )	#22(0.33mm <sup>2</sup> )	#20(0.52mm <sup>2</sup> )	#18(0.83mm <sup>2</sup> )
Resistance value(Ω/m)	0.078	0.050	0.030	0.018
Voltage drop(V/m)	0.028	0.018	0.011	0.006

- Therefore having an excessively long distance between the power adaptor and the camera may affect the camera's performance.
- ※ Standard voltage for camera operation : DC 12V±10%, AC 24V±10%
- ※ There may be some deviation in voltage drop depending on the type of wire and the manufacturer.
- ※ The set for America does not include the power adapter.



### Notes

- Please use a power adapter that meets the required standards.
- Please connect the power after installation.

# Connection

## RS-485 communication control

### Connecting to RS-485 Control Cable

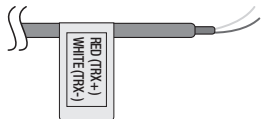

CONTROL CABLE	SPEC
RED (TRX+)	RS-485+
WHITE (TRX-)	RS-485-

Using RS-485 communication will enable you to control the OSD menu from a SAMSUNG TECHWIN System Controller or DVR.

#### (1) Connection to a PC.

Connect the camera to the PC via a RS-485 converter using RS-485 and a serial cable.  
EX) SERIAL PORT OF THE PC(COM1) → SERIAL CABLE → RS-485 CONVERTER → RS-485 CONTROL CABLE

#### (2) Connection to a DVR or System Controller.

Connect the RS-485 cable to the connection ports of the DVR or System Controller.

485 Control Board Connection Port	RS-485 Control Port
(+) CONNECTION TERMINAL	RED (TRX+)
(-) CONNECTION TERMINAL	WHITE (TRX-)

\* RS-485 Communication establishment initial value

Item	Camera ID	BAUD RATE	UART MODE	RET PKT
Initial value	1	9600	8-NONE-1	ENABLE



### Notes

- When building a control system to control the camera, please use to the STW(SPD)PROTOCOL or PELCO-P, PELCO-D, VICON, AD, PANASONIC, BOSCH, HONEYWELL, SEC PROTOCOL.
- When you connecting to RS-485 control cable, please peel off the outer skin inside the RS-485 control cable.
- In case of SCC-101 connection, change communication mode to 「8-E-1」 at 「Communication configuration」 menu. (For more information, refer to SCC-101 manual.)

## Using Coaxial Communications

- Coaxial Communications System
- OSD Control method

CAMERA	DVR	CONTROLLER
SET	MENU / ENTER	OSD KEY
UP	UP KEY	JOYSTICK UP
DOWN	DOWN KEY	JOYSTICK DOWN
LEFT	LEFT KEY	JOYSTICK LEFT
RIGHT	RIGHT KEY	JOYSTICK RIGHT

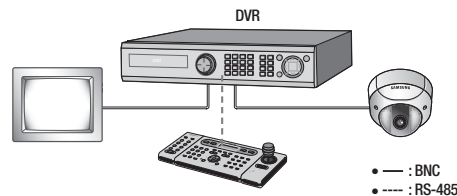

#### -Video Cable

The camera's video output port is connected to the monitor with a BNC coaxial cable, shown below : If the distance between the camera and the monitor exceeds the recommended maximum, please use an auxiliary video amp.

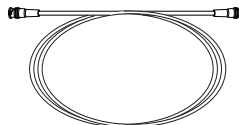

Distance	Recommended Cable Specification
300m	3C2V(RG-59/U)
450m	5C2V(RG-6/U)
600m	7C2V(RG-11/U)



### Notes

- If the camera is controlled through coaxial communication, please use a video amp intended for coaxial communications. Regular video amps do not transfer coaxial signals.



# Operating Your Camera

## Menu Configuration

MAIN SETUP MENU			
SSDR	● OFF	● ON	
WHITE BAL	● ATW ● OUTDOOR	● MANUAL ● INDOOR	● AWC→SET
BACKLIGHT	● OFF	● BLC	● HLC
MOTION DET	● OFF	● ON	
FOCUS↵	● MODE ● D-ZOOM ● LENS INIT	● ZOOM TRACK ● ZOOM POS INIT ● RETURN	● ZOOM SPEED ● USER PRESET
EXPOSURE↵	● BRIGHTNESS ● AGC ● RETURN	● IRIS ● SSNR	● SHUTTER ● SENS-UP
SPECIAL↵	● PRIVACY ● SYNC ● MONITOR	● DAY/NIGHT ● COMM ADJ ● DISPLAY	● DIS ● IMAGE ADJ ● RETURN
RESET			
EXIT			

## Menu Setup

Use the Function Setup switch within the camera.

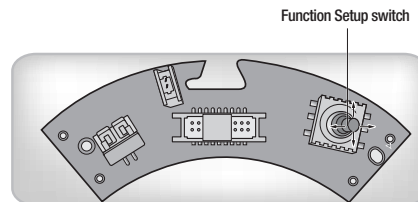

1. Press the Function Setup switch.
  - Main setup menu is displayed on the monitor screen.

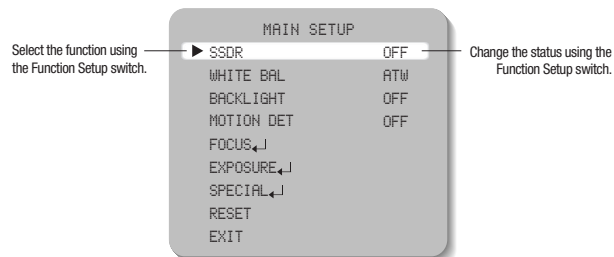

2. Select a desired function using the Function Setup switch.
  - Place the cursor over a desired item.
3. Set up a selected item by using the Function Setup switch.
4. To finish the setting, select 'EXIT' and press the Function Setup switch.



### Notes

- An item with the ↵ icon also has sub menus. To select a sub menu, select an item with the icon and press the Function Setup switch.
- An item with the --- icon is unavailable due to function settings.

# Operating Your Camera

## SSDR (Samsung Super Dynamic Range)

SSDR illuminates darker spots of an image while retaining the same light level for brighter spots to even out the overall brightness of images with high contrast between bright and dark spots.

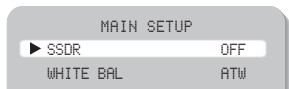

1. When the SETUP menu screen is displayed, select 'SSDR' by using the switch so that the arrow indicates 'SSDR'.
2. Use the switch to change the SSDR level according to the contrast between bright and dark areas.

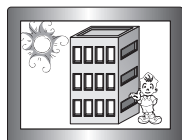

SSDR ON

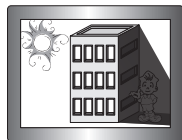

SSDR OFF

## White Balance (White Bal)

Use the White Balance function to adjust the screen color.

1. When the SETUP menu screen is displayed, select 'White Bal' by using the Function Setup switch so that the arrow indicates 'White Bal'.
2. Select a desired mode using the Function Setup switch.

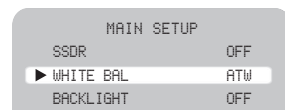

※ Select one of the following 5 modes, as appropriate for your purpose.

- ATW : Select this when the color temperature is between 1,800°K and 10,500°K.
- MANUAL : Select this to fine-tune White Balance manually. Set White Balance first by using the ATW or AWC mode. After that switch to MANUAL mode, fine-tune the White Balance and then press the Function Setup switch.
- AWC → SET : To find the optimal luminance level for the current environment, point the camera towards a sheet of white paper and press the Function Setup switch. If the environment changes, readjust it.
- OUTDOOR : Select this when the color temperature is between 1,700°K and 11,000°K. (sodium light inclusion)
- INDOOR : Select this when the color temperature is between 4,500°K and 8,500°K.



### Notes

- White Balance may not work properly under the following conditions. In this case select the AWC mode.
  - ① When the color temperature of the environment surrounding the subject is out of the control range (e.g. clear sky or sunset).
  - ② When the ambient illumination of the subject is dim.
  - ③ If the camera is directed towards a fluorescent light or is installed in a place where illumination changes dramatically, the White Balance operation may become unstable.

# Operating Your Camera

## BACKLIGHT

Unlike conventional cameras, the SVD-4700 is designed to deliver a distinctive subject and background at the same time, even when the subject is backlight, by using the features of the proprietary W-V DSP chip.

1. When the SETUP menu screen is displayed, select 'BACKLIGHT' by using the Function Setup switch so that the arrow indicates 'BACKLIGHT'.

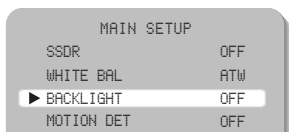

2. Select a desired mode using the Function Setup.

- OFF : Not being used
- BLC : Enables a user to directly select a desired area from a picture, and to view the area more clearly.
- HLC (High Light Compensation) :  
If the scene contains extremely bright light areas such as; from car headlight, the light can mask out much of the on-screen detail.
  - LEVEL : Adjust level of the HLC function.(LOW,MIDDLE,HIGH)
  - MASK TONE : Change the brightness
  - LIMIT : Enable to change the operating condition.

3. Select a desired mode using the Function Setup switch and press the Function Setup switch.

- Select 'BLC' to adjust the area to be enhanced then adjust the level.
- HLC : Enable the user to change the level, mask tone area.

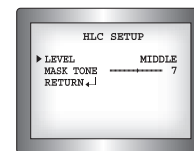
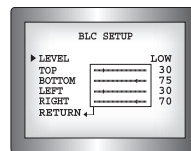

### Notes

- For effective viewing of license plates, there is a minimum required illumination and the shutter speed needs to be faster than 1/200sec.
- Because there can be a difference in the effectiveness of HLC according to the amount of light area in the screen, optimize the installation angle for the best HLC performance.
- When dark, the HLC is only activated when a bright light exceeding a specific size. (In NIGHT ONLY mode.)
- The HLC is not activated in day light or when bright light is not present at night. (In NIGHT ONLY mode.)
- The HLC is not activated when the D-ZOOM mode is 'ON' or DIS mode is 'ON'.

# Operating Your Camera

## Motion Detection

This product has a feature that will detect movements of objects in 8 different areas on the screen. The camera detects an object's movement by sensing disparity of outline, brightness levels and color. The camera sends a detection signal out via the MD output terminal and will zoom into a pre-determined point.

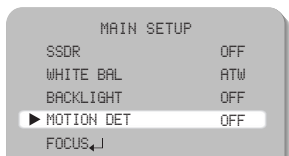

1. Please press the Function Setup Switch.

- OFF : MOTION DETECTION mode is cancelled.
- ON : Any motion in the selected areas is observed.
- AREA SEL : You can select 8 different sensitivity MOTION DET area.

MOTION DET SENSITIVITY		
AREA1 MIN	→	AREA8 MAX

- AREA MODE : Determines whether to use the MD area selected in SENSITIVITY.
- SEL POS(XPOS/YPOS) : You can control MD area size.
- SMART ZOOM : Smart zoom is operated in connection with MOTION DETECTION. When the SMART ZOOM function is 'ON' while the MOTION DETECTION mode is 'ON', the zoom goes to the TARGET ZOOM position once motion is detected. Once the zoom action is finished and 'DWEELL TIME' has passed, the zoom returns to the 'START ZOOM' position.



- START ZOOM : By moving the left or right direction of the Function Setup Switch in the 'START ZOOM' item to select the zoom position from 1x to 12x to be returned after the 'SMART ZOOM' action is over.
- TARGET ZOOM : By moving the left or right direction of the Function Setup Switch in the 'TARGET ZOOM' item to select the zoom position from 1x to 12x to be used during MOTION DETECTION.
- DWEELL TIME : By moving the left or right direction of the Function Setup Switch in the 'DWEELL TIME' item to select a time between 5 and 60 seconds for the dwell time before the zoom is returned to the 'START ZOOM' position. (5,7,10,15,20,30,40,60 sec)



### Notes

#### Tips on Using the Motion Detection Feature

- The feature may not function properly under flickering light conditions.
- The camera interprets sudden changes in lighting and subsequent change in brightness of an object as motion.
- With the feature enabled, other algorithms may require additional time to operate.



### Notes

- This system does not guarantee prevention of fire or theft. The manufacturer shall not be held responsible for any accident or damage incurred.
- Connect an external alarm device to MD Out on back of the camera.

# Operating Your Camera

## FOCUS

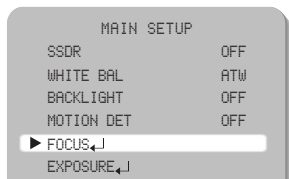

1. Press the Function Setup Switch to access the main setup menu and then position the indicator over FOCUS moving the up or down direction of Function Setup Switch.
2. Press the Function Setup Switch.

➡ **MODE** : You can select the most suitable zoom mode. Move the arrow indicator to 'MODE' by moving the up or down direction of the Function Setup Switch

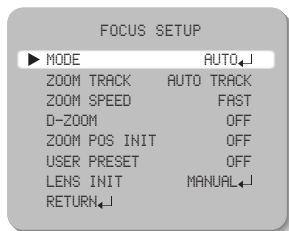

- **AUTO** : Select AUTO and press the Function Setup Switch to confirm. Increase or decrease optical zoom (ZOOM) or digital zoom (D-ZOOM) positions by moving the up or down direction of the Function Setup Switch while verifying the changes on screen. Enabling D-ZOOM (ON) means that digital zoom will activate once optical zoom ends. The focus automatically adjusts when the lens zooms in and out.



- **ONE PUSH** : Focus is automatically adjusted just once, after zoom position is changed. Select 'ONE PUSH' and press the Function Setup Switch to confirm. Increase or decrease optical zoom (ZOOM) or digital zoom (D-ZOOM) positions by moving the directional key of Function Setup Switch while verifying the changes on screen. Press the Function Setup Switch once the desired image quality is obtained.

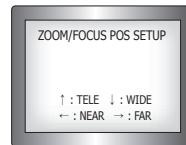

- **MANUAL** : Select 'MANUAL' and press the Function Setup Switch to confirm. Increase or decrease optical zoom (ZOOM) or digital zoom (D-ZOOM) positions moving directional key of Function Setup Switch while verifying the changes on screen. Press the Function Setup Switch until the desired image quality is obtained. Focus can be manually adjusted, independent of moving zoom.

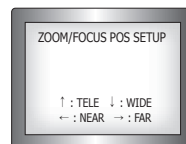

➡ **ZOOM TRACK** : Select 'ON' for the 'SMART ZOOM' item in the MOTION DETECTION menu and press Function Setup Switch to change the settings for the 'SMART ZOOM' function.

By moving the left or right direction of the Function Setup Switch in the 'ZOOM' item to select 'AUTOTRACK' or 'TRACK' and press Function Setup Switch to activate the zoom action focus function.

- **AUTO TRACK** : Zooming in while deciding or adjusting the status of the focus.
- **TRACK** : The camera moves the focus track which is established.
- **OFF** : Only the zoom lens moves.

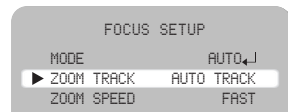

## Operating Your Camera

- **ZOOM SPEED** : Configure zoom tracing speed using this feature. Position the indicator over 'ZOOM SPEED' by moving the up or down direction of the Function Setup Switch and then set to desired mode by moving the left or right direction of the Function Setup Switch

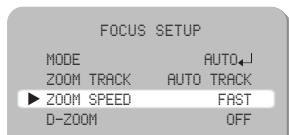

- FAST : To move zoom fast.
- SLOW : To move zoom slowly.
- MEDIUM : To move zoom at medium speed.

- **D-ZOOM** : Configure magnification limit from x2~x16 using this feature. Position the indicator over 'D-ZOOM' by moving the up or down direction of the Function Setup Switch Set 'D-ZOOM' to 'ON' and press the Function Setup Switch to confirm.

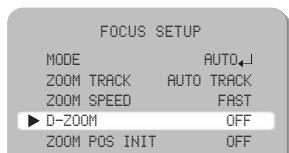

- Set 'ZOOM LIMIT' to the desired level by moving the left or right direction of the Function Setup Switch.



### Notes

- When the DIS is enabled, you cannot use the D-ZOOM.

- **ZOOM POS INIT** : Moves to the controlled ZOOM position when the power is turned on and the initial ZOOM position has been set.

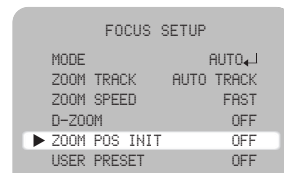

- **AUTO** : If you turn the power off and on, the zoom magnification level is set to the previous level that was set before the power went off.
- **MANUAL** : The zoom magnification level can be set from 1x to 12X.

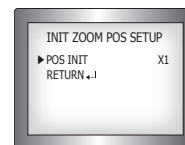

### Notes

- The zoom position is saved after 5 seconds when you set zoom function.

- **USER PRESET** : Preset user-designated configurations using this feature. Position the indicator over 'USER PRESET' by moving the up or down direction of the Function Setup Switch and then set to 'ON' by moving the left or right direction of the Function Setup Switch. Press the Function Setup Switch to confirm.

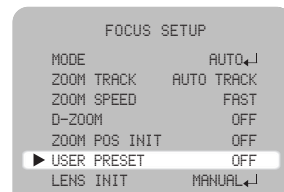

## Operating Your Camera

- PRESET NO : Up to 128 preset configurations are supported.
- SAVE : Save configured preset.
- CLEAR : Clear configured preset.
- RETURN : Revert to the FOCUS SETUP menu.

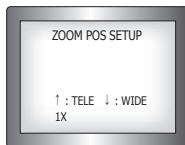

- LENS INIT : By moving the left or right direction of the Function Setup Switch in the 'Lens initialization' item select 'Automatic' or 'Manual' and then press the SET button.

- AUTO : The lens can automatically be set by a pre-selected day, from 1-day to 7-days. This will start from when the time is set.
- Manual : The Lens will reset when you press the Function Setup Switch.

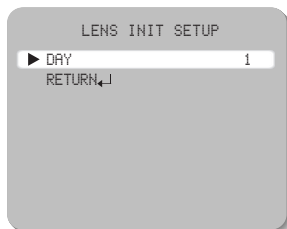
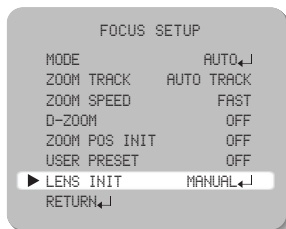
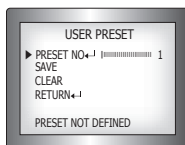

## EXPOSURE

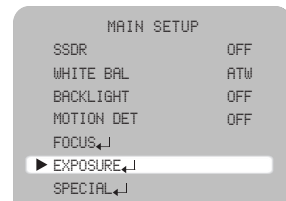

1. Press the Function Setup Switch to access the main setup menu and then position the indicator over 'EXPOSURE' by moving the up or down direction of the Function Setup Switch.
2. Press the Function Setup Switch to confirm.

- BRIGHTNESS : Use this feature to adjust image brightness. Position the indicator over 'BRIGHTNESS' by moving the up or down direction of the Function Setup Switch. Then increase or decrease brightness level by moving the up or down direction of the Function Setup Switch while verifying the changes on screen. Set END once desired level is obtained.

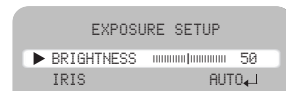

- IRIS : Set 'IRIS' to 'AUTO' or 'MANUAL'. Position the indicator over 'IRIS' by moving the up or down direction of the Function Setup Switch and then select the desired iris mode by moving the left or right direction of the Function Setup Switch.

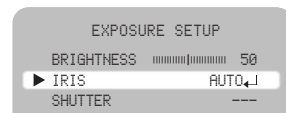

- AUTO : The iris is automatically activated upon illumination.
- MANUAL : Manual iris configuration. Set 'IRIS' to 'MANUAL' by moving the left or right

## Operating Your Camera

direction of the Function Setup Switch and then press the Function Setup Switch. Increase or decrease iris level by moving the left or right direction of the Function Setup Switch while verifying the changes on screen.



⇨ **SHUTTER** : Control image brightness by adjusting shutter speed.

- Position the indicator over 'SHUTTER' by moving the up or down direction of the Function Setup Switch. Then select the desired shutter mode (A.FLK, ESC, MANUAL) by moving the up or down direction of the Function Setup Switch.

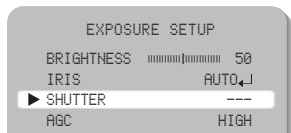

- MANUAL : Manual shutter speed setting.
- A.FLK (NTSC: 1/100, PAL: 1/120) : Flicker-free mode.
- ESC : Automatic shutter speed setting (optimal).

Auto operation is possible only when the IRIS is set to MANUAL.

- If you choose 'MANUAL', select the optimal shutter speed.

- In MANUAL mode, the optimal shutter speed needs to be designated. Select from 1/60 to 1/120,000 (NTSC) or from 1/50 to 1/120,000 (PAL). \* 'Sens-Up' mode can be configured manually (2x to 512x).
- Verify changes made to the shutter speed by referencing to changes the 'on-screen' brightness.

- Press the Function Setup Switch to complete.

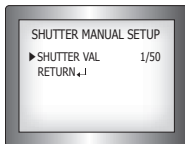

### Notes

- Image may become unstable if the camera is set to 'ESC' mode and faces a strong fluorescent light.
- Under 'ESC' mode, the brightness can be adjusted by moving the left or right direction of the Function Setup Switch

⇨ **AGC (Auto Gain Control)** : For brighter images.

- Position the indicator over 'AGC' by moving the up or down direction of the Function Setup Switch.
- Set 'AGC' to the desired mode by moving the left or right direction of the Function Setup Switch.
  - HIGH : Wide range gain value adjustment
  - MANUAL : Selecting gain value range. (5dB ~ 41dB)
  - OFF : Disabled
  - LOW : Narrow range gain value adjustment
  - MEDIUM : MEDIUM range gain value adjustment

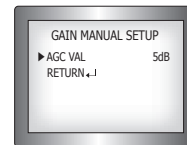
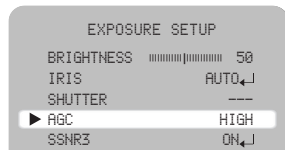

⇨ **SSNR(Samsung Super Noise Reduction)** : On screen noise reduction.

- Position the indicator over 'SSNR3' by moving the up or down direction of the Function Setup Switch.
- Set 'SSNR3' to the desired mode by moving the left or right direction of the Function Setup Switch.
  - OFF : Disabled

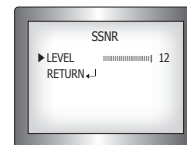



## Operating Your Camera

### Notes

- Changing the 'AGC' setting from LOW to HIGH results in greater sensitivity, as well as on screen noise.
- Setting 'AGC' to OFF locks 'SSNR3' configuration.

➤ SENS-UP : This feature ensures clear images at night or under low light conditions.

- 1 Position the indicator over 'SENS-UP' by moving the up or down direction of the Function Setup Switch.
- 2 Set 'SENS-UP' to the desired mode by moving the left or right direction of the Function Setup Switch.
  - AUTO : Select this mode for use in night time or under low light conditions.
  - OFF : Disabled

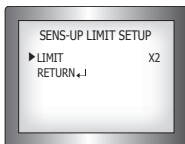

### Notes

- Once 'AUTO' mode is set, the user can configure the SENS-UP limit by increasing/decreasing the shutter speed (e.g.: X2, X4..... X32, X64, X128, X256, X512).
- Enabling Sens-Up increases camera sensitivity and may result in additional noise and/or other phenomena. This is normal.

## SPECIAL

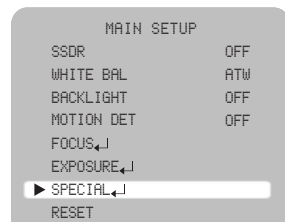

1. Press the Function Setup Switch to access the main setup menu and then position the indicator over 'SPECIAL' by moving the up or down direction of the Function Setup Switch.
2. Press the Function Setup Switch to confirm.

➤ PRIVACY : Hide an area you want to hide on the screen.

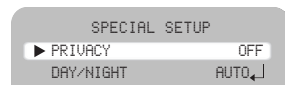

- 1 When the SPECIAL menu screen is displayed, by moving the up or down direction of the Function Setup Switch so that the arrow indicates 'PRIVACY'.

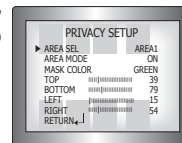

- 2 Set up the mode using the 4 direction buttons.
  - AREA SEL : You can select up to 12 MD areas.
  - AREA MODE : Determines whether to use the area selected in the AREA SEL.
  - MASK COLOR : Determine area color. You can select Green, Red, Blue, Black, White, Gray.

## Operating Your Camera

☞ DAY/NIGHT : You can display pictures in color or black and white.

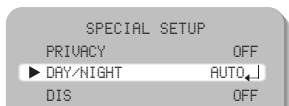

- When the SETUP menu screen is displayed, select 'DAY/NIGHT' by moving the up or down direction of the Function Setup Switch so that the arrow indicates 'DAY/NIGHT'.
- Select a desired mode by moving the left or right direction of the Function Setup Switch according to the picture display you want.

- AUTO : The mode is switched to 'Color' in a normal environment, but switches to 'B/W' mode when ambient illumination is low. To set up the switching time or speed for AUTO mode, press the Function Setup Switch.

- COLOR : The picture is always displayed in color.

- B/W : The picture is always displayed in black and white.

- DWELL TIME : You can select tday/night switching delay time from.  
→ 5,7,10,15,20,30,40, 60(sec)
- DURATION : You can select the day/night switching point(lux).

	Color → B/W	B/W → Color
Fast	1.5 lux	2.0 lux
Slow	0.7 lux	1.2 lux

※ When AGC is middle mode.

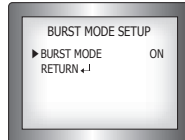
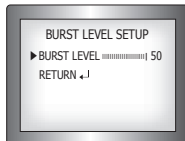
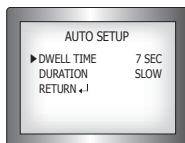

### Notes

- When using a Video Auto Iris Lens, if you set the lens level to low, automatic switching between Color and Black & White may not occur.
- You cannot control the DAY/NIGHT menu when AGC in the EXPOSURE menu is 'OFF'. At this time, the exchange between DAY mode and NIGHT mode operates as like selecting 'COLOR' mode.
- The OSD key does not work for 3 seconds when switching to Color or B/W, to ensure stable camera operation.
- The camera may focus less well under infrared illumination than under normal illumination.
- Since the camera may not focus as well under infrared illumination at night as it does under normal illumination, install an Extra-low Dispersion Lens to obtain sharp pictures.
- The brightness of illumination is changeable by installed environment.

☞ DIS : The DIS mode can compensate for vibration of the camera.

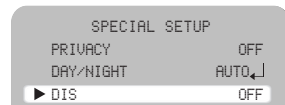

### Notes

- When DIS is operating, D-ZOOM does not operate.

☞ SYNC : Two synchronization modes are available INTERNAL and EXTERNAL LINE-LOCK. In LINE-LOCK mode, it synchronizes the camera's video out signal to the external SYNC signal.

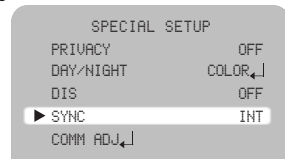

# Operating Your Camera

- INT : Internal synchronization
- LL : External line-lock synchronization
  - If you choose 'LL', you can adjust the desired phase. Press the SET button.
  - You can adjust the desired phase from 0 to 359.

☞ COMM ADJ (Communication Adjustment) : This function sets up the camera communication status when controlling the camera through an external controlled device.

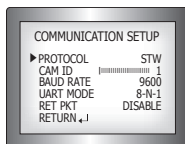

- 1 When the SPECIAL menu screen is displayed, by moving the up or down direction of the Function Setup Switch so that the arrow indicates 'COMM ADJ'.
- 2 Set up the mode moving the 4 direction of Function Setup Switch.
  - CAM ID : Determines the camera's identification number (between 0 and 255).
  - Protocol : Select the communication PROTOCOL. (STW/PELCO-D/PELCO-P/ BOSCH/ HONEYWELL/VICON/AD/SEC/PANASONIC)
  - BAUD RATE : You can select 2400/4800/9600/19200/38400/57600 bps.
  - UART MODE : You can select NONE, EVEN or ODD for the parity bits.

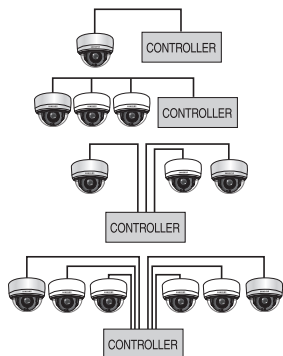

- RET PKT : You can choose whether to send an ACK signal when the communication control command is issued to the camera.

☞ IMAGE ADJ : Includes image quality or special function factors.

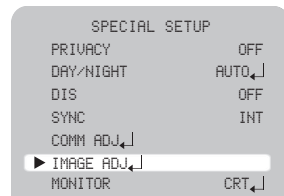

- 1 When the SETUP menu screen is displayed, select 'IMAGE ADJ.' by moving the up or down direction of the Function Setup Switch so that the arrow indicates 'IMAGE ADJ'.
- 2 Select a desired mode by moving the up or down direction of the Function Setup Switch.
  - H-REV : You can flip the picture horizontally on the screen.
  - V-REV : You can flip the picture vertically on the screen.
  - SHARPNESS : As you increase this value, the picture outline becomes stronger and clearer.

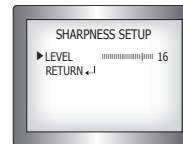

# Operating Your Camera

Monitor : Please change the settings value of video appropriate to your monitor.

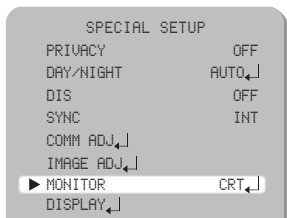

- LCD : Please select this menu item when using an LCD monitor.

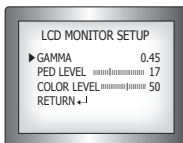

- CRT : Please select this menu item when using a CRT monitor.

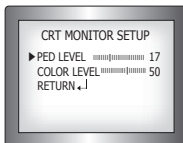

- USER : Please use this menu item when using a monitor other than standard ones. You can change the gamma, PED level, and color gain in the sub menus.

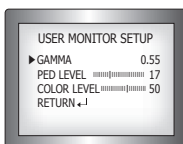

DISPLAY : Use this feature to designate a name for the camera, which will display on the monitor screen

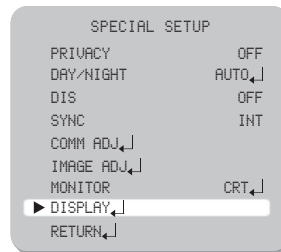

CAM TITLE

- 1 Press the Function Setup Switch to display the main setup menu and move the arrow indicator to 'CAM TITLE' by moving the up or down direction of the Function Setup Switch.
- 2 Set 'CAM TITLE' to 'ON' by moving the left or right direction of the Function Setup Switch.



### Notes

- If the CAM TITLE feature is set to 'OFF', the name will not displayed in the monitor

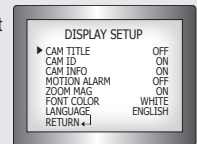

- 3 Press Function Setup Switch.

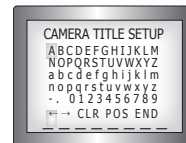

## Operating Your Camera

- 4 You can enter up to 15 characters.
  - a. Move the cursor to the character entry field moving left or right direction of Function Setup Switch.
  - b. Use the 4 direction of Function Setup Switch to select a desired character.
  - c. Press the Function Setup Switch to confirm the selection of the blinking character. The character is then saved, and the cursor in the entry field moves to the next position.
  - d. Repeat steps 'a' through 'c' until the desired name has been entered.

### Notes

#### • Correcting Mistakes

Move the cursor th 'CLR' and press the Function Setup Switch to clear the entire entry. To modify one character, use LEFT or RIGHT to position the cursor above the character to be modified and click the Function Setup Switch after selecting the character to enter.

- 5 Enter a title, move the cursor to 'POS' and press the Function Setup Switch. The entered title appears on the screen. Select the position to display the title on the screen by moving the 4 direction of Function Setup Switch and press the Function Setup Switch. When the position is determined, select.



- CAM ID : Displays camera ID on top left corner of the screen.
- CAM INFO : Displays camera information on screen.
- MOTION ALARM : You can toggle the use of the camera alarm.
- ZOOM MAG : Use th is feature to display the current zoom magnification level on screen. Position the indicator over 'ZOOM MAG' by moving the up or down direction of the Function Setup Switch. Then set to ON by moving the left or right direction of the Function Setup Switch.
- FONT COLOR : You can select the font color(white,yellow,green,red,blue)
- LANGUAGE : You can select the menu language according to your requirements (Korean, ESPANOL, FRANCAIS, ITALIANO, DEUTSCH, ENGLISH, Japanese, Chinese, RUSSIAN, CESKY, POLSKI, PORTUGUESE, Taiwanese, Romanian, Serbian, Swedish, Danish, Turkish)
- END : Select this to save the SPECIAL menu settings and return to the SPECIAL menu.

### RESET

To reset your camera to factory default condition.

### EXIT

To finish setup menu.

If you have trouble operating your camera, refer to the following table. If the guidelines do not enable you to solve the problem, contact an authorized technician.

**• Nothing appears on the screen.**

- ▶ Check that the power cord and line connection between the camera and monitor are fixed properly.
- ▶ Check that you have properly connected VIDEO cable to the camera VIDEO output jack.

**• The image on the screen is dim.**

- ▶ Is lens stained with dirt? Clean your lens with soft, clean cloth.
- ▶ Set the monitor to proper condition.
- ▶ If the camera is exposed to too strong light, change the camera position.

**• The image on the screen is dark.**

- ▶ Adjust the contrast feature of the monitor.
- ▶ If you have an intermediate device, set the 75Ω / Hi-z properly.

**• The camera is not working properly, and the surface of the camera is hot.**

- ▶ Check that you have properly connected the camera to an appropriate power source.

**• The SENS-UP function does not work.**

- ▶ Check that AGC of EXPOSURE SETUP menu is 'OFF'.
- ▶ Check that SHUTTER of EXPOSURE SETUP menu is 'A.FLK' or 'MANUAL'.

**• The Motion Detection function does not work.**

- ▶ Check that MOTION DET of SPECIAL SETUP menu is 'OFF'.

**• Color is not correct.**

- ▶ Check the setting of WHITE BAL SETUP menu .

**• The screen flickers continually.**

- ▶ Check that direction of camera turns toward the Sun.

**• When coaxial communication is not available:**

- ▶ Make sure that the camera and monitor are installed within the recommended distance.
- ▶ Use the video amplifier equivalent to coaxitron if the recommended installation distance is exceeded.

	SVD-4700N	SVD-4700P
<b>POWER</b>		
Input Voltage	AC 24V(±10%) , DC 12V(±10%)	
Power Consumption	MAX 4.0W	
<b>CCD</b>		
Imaging Device	1/4 inch, Super HAD color CCD	
Total Pixels	811(H) x 508(V)	795(H) x 596(V)
Effective Pixels	768(H) x 494(V)	752(H) x 582(V)
<b>OPTICS</b>		
Optics	12X f=3.94mm(WIDE) ~ 46.05mm(TELE) / F1.67 ~F1.88	
Min. Focus Distance	1,800mm(TELE)	
D. ZOOM	OFF/ON (Limit 16x)	
Angle Field of view	H : Appr. 51.54°(Wide) to 4.50°(Tele) / V : Appr. 39.24°(Wide) to 3.38°(Tele)	
<b>SYNC</b>		
Scanning System	2:1 Interlace	
Synchronization	Internal / Line-Lock	
Frequency	H : 15.734 KHz / V : 59.94 Hz	H : 15.625 KHz / V : 50.00 Hz
<b>ELECTRICAL</b>		
Resolution	Color : 580TV Lines(Min.) / B/W : 680TV Lines(Min.)	
Min. Illumination	Color : 0.2 Lux/F1.6 (50 IRE) / B/W : 0.004 Lux/F1.6 (50 IRE)	
S/N (Y signal)	52 dB (AGC Off, Weight ON)	
Video Output	CVBS : 1.0Vp-p/75Ω	
Focus	Auto / Manual / One push	
Zoom Movement Speed	1.9 sec : Wide to Tele	
IRIS Control	Auto, Manual	
Lens Initialize	Built-In	
Camera Title	OFF / ON (Displayed 15 characters)	
Camera ID	255 ID Selectable	
Day & Night	Auto / COLOR / B/W	
Gain Control	LOW / MEDIUM / HIGH / MANUAL / OFF	
White Balance	ATW / AWC / MANUAL / INDOOR / OUTDOOR (1,700k ~ 11,000k)	
Back Light Compensation	SSDR / BLC / HLC / OFF	
SHUTTER	ESC / FLK / MANUAL (1/60(PAL 1/50) ~ 1/120K sec, x2 ~ x512 sec)	
O.S.D	Korean, English, Japanese, Spanish, French, Portuguese, Taiwanese	English, Spanish, French, Italian, German, Polish, Russian, Czech, Chinese, Portuguese, Romanian, Serbian, Swedish, Danish, Turkish

## Specifications

Motion Detection	ON / OFF (output via communication)
Control output	RS-485 (2400,4800,9600,19200,38400,57600bps)
SSNR3	ON / OFF (2D+3D), Level adjustable
Protocol	STW, PELCO-D, PELCO-P, BOSCH, HONEYWELL, VICON, AD, SEC, PANASONIC
SENSUP	Auto / Off (Selectable x2 ~ x512)
Privacy Function	ON / OFF(12 Areas)
MIRROR	ON / OFF
PRESET	ON / OFF(128 Point)
<b>ENVIRONMENTAL</b>	
Operating Temperature / Humidity	-10°C to +50°C / 20% to 80% RH
<b>MECHANICAL</b>	
Water Resistance	IP66
Dimension	Ø148 x 126 mm
Weight	1.38Kg

※ The specification for this product may change without prior notice for product improvement.

## Dimension

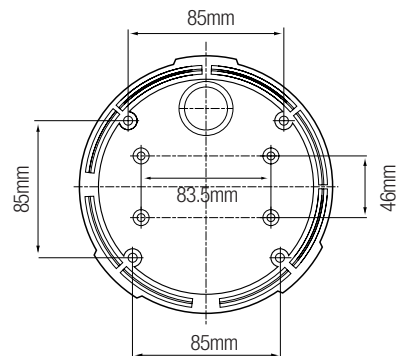
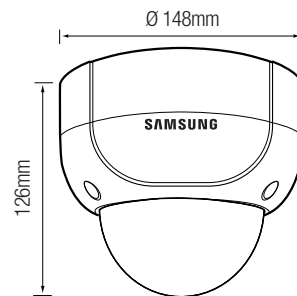

## DECLARATION OF CONFORMITY

Application of Council Directive(s)	89 / 336 / EEC
Manufacturer's Name	SAMSUNG TECHWIN CO., LTD
Manufacturer's Address	SAMSUNG TECHWIN CO., LTD 42, SUNGJU-DONG CHANGWON-CITY, KYUNGNAM, KOREA, 641-716
European Representative Name	
European Representative Address	
Equipment Type/Environment	CCTV Camera
Model Name	SVD-4700P
Beginning Serial NO.	C10S7010007
Year of Manufacture	2009.10.22
Conformance to	EN 50081-1 : 1992 EMC-Directive 89/336 EEC and 92/31/EEC EN 50130-4 : 1996

We, the undersigned, hereby declare that the equipment specified above conforms to the above Directive(s).

Manufacturer	SAMSUNG TECHWIN CO., LTD	Legal Representative in Europe
Signature	<i>BonJeng Gu</i>	Signature
Full Name	BONJENG GU	Full Name
Position	QUALITY CONTROL MANAGER	Position
Place	CHANGWON, KOREA	Place
Date	2009.10.22	Date

## MEMO



# SAMSUNG TECHWIN

The Samsung logo, consisting of the word "SAMSUNG" in a bold, sans-serif font, enclosed within a black, horizontally-oriented oval shape.

## SALES NETWORK

---

• **SAMSUNG TECHWIN CO., LTD.**

145-3, Sangdaewon 1-dong, Jungwon-gu, Seongnam-si Gyeonggi-do, Korea, 462-703  
TEL : +82-31-740-8151-8 FAX : +82-31-740-8145

• **SAMSUNG TECHWIN AMERICA Inc.**

1480 Charles Willard St, Carson, CA 90746, UNITED STATES  
Tol Free : +1-877-213-1222 FAX : +1-310-632-2195  
[www.samsungcctvusa.com](http://www.samsungcctvusa.com)

• **SAMSUNG TECHWIN EUROPE CO., LTD.**

Samsung House, 1000 Hillswood Drive, Hillswood Business  
Park Chertsey, Surrey, UNITED KINGDOM KT16 0PS  
TEL : +44-1932-45-5300 FAX : +44-1932-45-5325

---

[www.samsungtechwin.com](http://www.samsungtechwin.com)  
[www.samsungcctv.com](http://www.samsungcctv.com)